

BTC-1/DX

SCRAPER

KNIFE

As many as **11** positions!

Adjust to your needs with **Various Handle/Head Positions!**

ACETONE RESISTANT

ONE-SIDED SHARPENING

WHEEL LOCK

MODEL	BTC-1/DX	BARCODE	0 91511 23059 8	
PACKAGE	Blister Packed	INNER BOX	6 pcs.	100 91511 23059 5
PACKAGE SIZE	W116 x H240mm	MASTER CARTON	120 pcs.	500 91511 23059 3
DATE	October, 2022			

DESIGN OBJECTIVE

Amazing tool with an adjustable head that can be used as a Scraper or a Cutter!

OLFA BTC-1/DX is the enhanced version of the consistently popular BTC-1. Its greatest feature is the ability to freely change the position of the head. The position of the head can be easily changed with the screw lock, and the appropriate angle can be set for your task. For example, scraping along a wall can be done with ease by changing the angle of the head. On the other hand, when cutting leather, users can grip the knife as if wrapping it with their hand, making it easy to cut precisely. By switching the front and back of the blade, it can be used for a wide range of tasks.

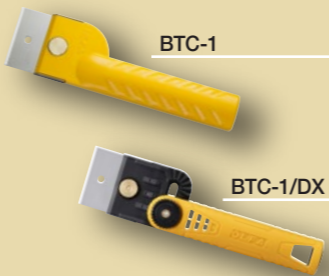

TARGET MARKET & MARKET TRENDS

Professional Tool Shops / Do-It-Yourself Stores / Leather Dresser / Hobby & Crafts (Leather Crafts)

For a wide range of applications, from professional workplaces to hobbyist leather craftspeople!

The BTC-1/DX will be welcomed by a wide range of users, from professionals that peel and shave with sharp-edged scrapers to hobbyists in leather crafting. Unlike traditional leather knives that require sharpening and maintenance, the BTC-1/DX is blade replaceable. With simple maintenance, users will always be able to work with a sharp edge.

FEATURES

Head can be adjusted in positions from ① to ⑪
Loosen the head fixing screw to free the head. Tighten it after deciding the position and align the triangle mark with the guide on the handle.
*Head cannot be angled when in the center position.

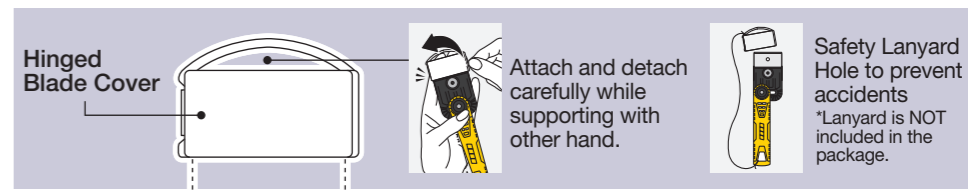

The head can be flipped to switch from using as a Scraper and as a Knife
Can be switched by loosening and removing the head fixing screw.
*Be careful not to lose the tiny nylon washer.

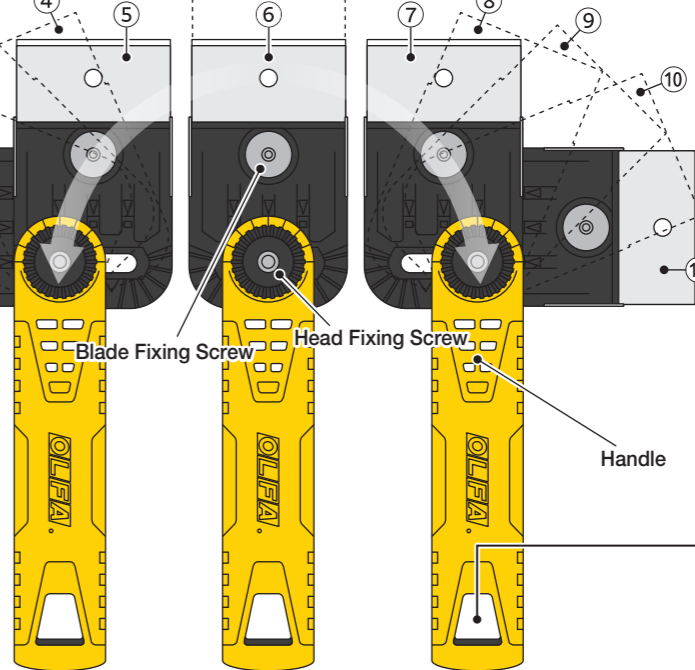

Compatible with large attachments

Designed to free water

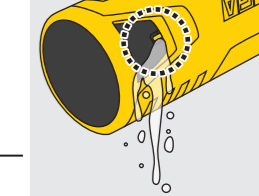

Handle allows water to drain easily from inside.

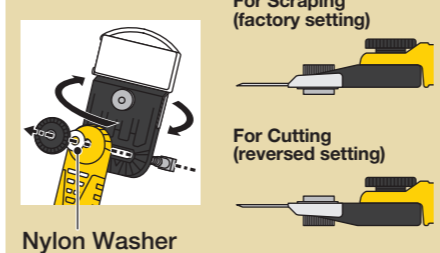

Cut leather at a more user-friendly angle!

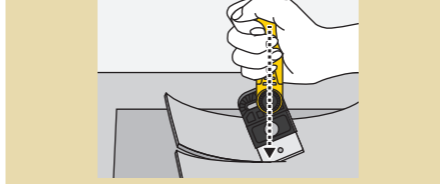

Convenient for tight areas!

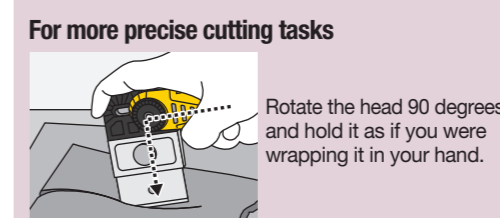
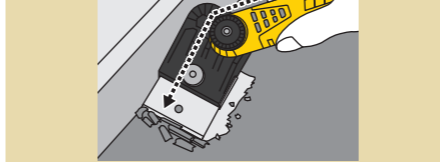

SPARE BLADE : BTB-1
2 edges per blade



To learn more



BTC-1

MODEL	BTC-1		
PACKAGE	Blister Pack	PACKAGE SIZE	W95 x H220mm
BARCODE	0 91511 40087 8		
INNER BOX	6 pcs.	200 91511 40087 2	
MASTER CARTON	120 pcs.	600 91511 40087 0	

MODEL	BTB-1 (3-blade pack)		
PACKAGE	Plastic Bag	PACKAGE SIZE	W70 x H107mm
BARCODE	0 91511 50129 2		
INNER BOX	6 pcs.	200 91511 50129 6	
MASTER CARTON	240 pcs.	600 91511 50129 4	

